

USER MANUAL



Thank you for choosing Better Bathrooms.
Please read this manual before installing your product
and keep for future reference.

better 
bathrooms

**Product name: Wave Wall Mounted
Basin Mixer –Matte Black
Product Code: BeBa-27761**



- **Single person assembly**
- **Tools required**
- **We always recommend using professional tradespeople to install your product**

V1 23.08.21

Congratulations on your purchase

And welcome to our growing gang of savvy shoppers

We're on a mission to bring you extraordinary bathroom products, for less. From modern to traditional style ceramics, plus the gorgeous fixtures, fittings and furniture to match. So, you can fall in love with your space every single day.

As one of the UK's largest independent bathroom stores, we've received countless awards; including the National Business Awards UK, the Digital Entrepreneur Awards and being placed on The Sunday Times Fast Track 100.

We hope your new product goes above and beyond your expectations. However, should any problems occur, please:

- log in to your account and contact our customer services team via your self-serve portal – betterbathrooms.com/Account/Login
- contact us via betterbathrooms.com/contact-us

Important information

- Please read these instructions thoroughly and retain for future reference
- Pressures should meet minimum stated on the website
- Pressures must be balanced for optimum performance
- Always check for pipes and cables before drilling
- System must be flushed through prior to installation

Contents

Dimension Drawing

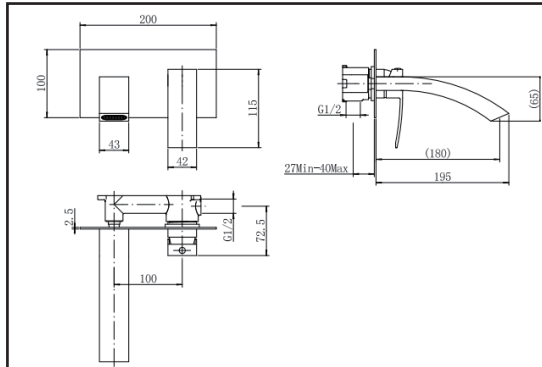

Tools required

Spanner ,Hammer , Screw Driver, PTFE etc

Parts / Diagrams

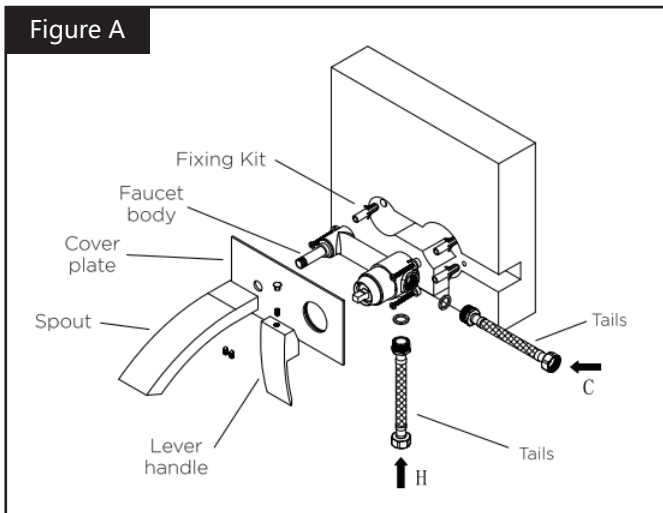

Installation should be as follows:

Please note: Before starting the installation of a new mixer, turn off water supply

Please note: HOT supply to the left and COLD supply to right

1. Determine the fixing position and prepare recess for the faucet body. Make the recess in the wall according to the dimension of the faucet body, the recess should be approximately 190mm x 45mm. The faucet body should be fitted below the finished surface to allow the cover plate to fit correctly and flush against the wall. Figure B

2. Position the faucet body in place and mark through the pre-drilled screw holes on the body, then drill the marked points before inserting wall plugs into the wall holes. Figure C

3. Connect the pipe supplies as shown in Figure B, then check for leaks before fitting plate, once checked turn off water supply

4. Apply silicone to the back of the cover plate as shown in Figure D and leave to dry for 24 hours

5. Fit handle and spout using the screws provided, Figure E

6. Installation is complete, turn on water supply. Figure F

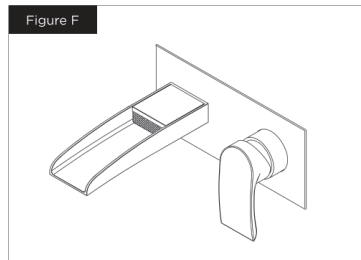
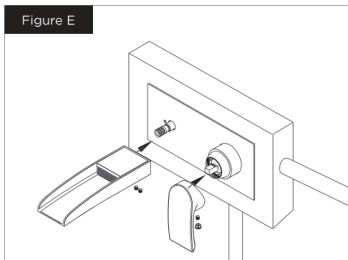
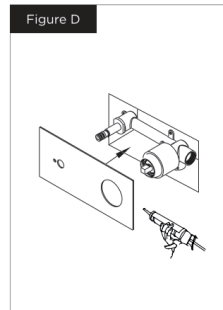
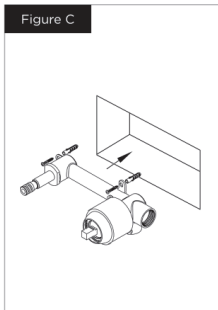
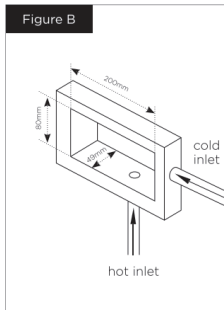

Cleaning

To maintain the surface finish of your product, wipe clean regularly, using a clean damp cloth and dry cloth to polish. Do not use abrasive cleaning agents or materials on the product surface as you may invalidate your guarantee. Should any harsh chemicals come into contact with the surface of the product during bathroom cleaning, rinse off immediately, wipe clean and dry.

For more information

- visit betterbathrooms.com
- email customerservices@buyitdirect.co.uk
- call 0330 390 3062
- write to Trident Business Park, Neptune Way, Huddersfield, HD2 1UA

better 
bathrooms

Part of the BuyItDirect Group